

Garraum	Spannung	Baugruppe	Ausgabe	gültig ab Seriennummer
Interior Cabinet	Voltage	Group	Edition	Application from Serial.No.
	3 N AC 400V 50Hz	7	7.1.1	C21M93065001

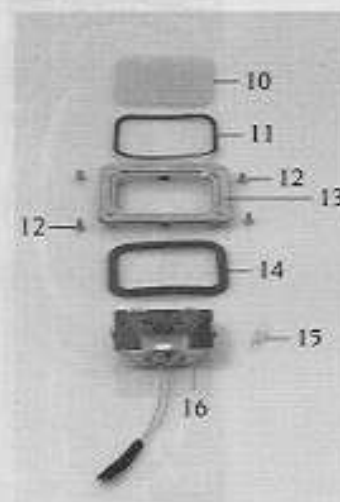

Pos.	St.	Ersatz.Nr.	Bezeichnung	Description
Pos.	Pcs.	Sp. Part No.		
-	1	8516.1011	Luftleitblech oben	Air baffle top
-	1	8516.1015	Luftleitblech unten	Air baffle bottom
-	1	2005.0302	Ablaufsieb	Outlet sieve
1	1	3035.0702	Einstechfühler	Meat probe sensor
2	1	1315.0105	Kupferdichtung für Einstechfühler	Copper gasket for meat probe sensor
3	4	2043.0203	Haltescheibe für Verschlußbolzen	Holder plate for air baffle
4	4	2043.0201	Verschlußbolzen für Luftleitblech	Locking pin for air baffle
5	1	3014.0160	Mantelthermoelement Garraum	Sheath thermo element
6	1	3014.0163	Stopfbuchsnippel für Thermoelement	Gasket sleeve with nipple
7	1	3014.0162	Dichtkegel für Thermoelement	Sealing cone for thermo element
8	1	3014.0322	Sicherheitstemperaturbegrenzer 360°C	Safety temperature limiter 360°C
9	1	2720.1073	Thermostathaltewinkel	Holding angle for thermostat
10	2	5201.1000	Glas f. Garraumbeleuchtung	Glass for interior lamp
11	2	5110.1022	Dichtungsrahmen außen f. Garraumbeleuchtung	External gasket frame
12	8	1008.0753	Sechskantschraube M5x8	Hexagonal screw M5x8
13	2	8514.1017	Andrückrahmen f. Garraumbeleuchtung	Press down frame
14	2	5110.1023	Dichtungsrahmen innen	Internal gasket frame
15	2	3024.0201	Halogengarraumlampe 10 W/12V/300°C	Halogen bulb 10 W/12V/300°C
16	2	8514.1018	Reflektor kpl. f. Garraumbeleuchtung	Reflector unit for interior lighting

Motor und Lüfterrad Motor and Fan Wheel	Spannung Voltage	Baugruppe Group	Ausgabe Edition	gültig ab Seriennummer Application from Serial.No.
	3 N AC 400V 50Hz	6	6.1.1	C21M93065001

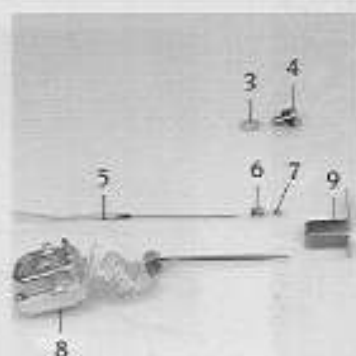
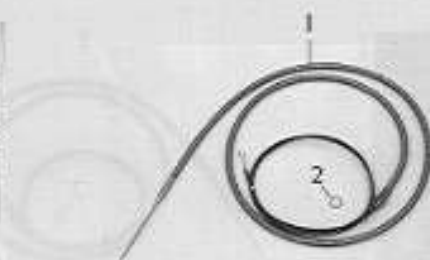
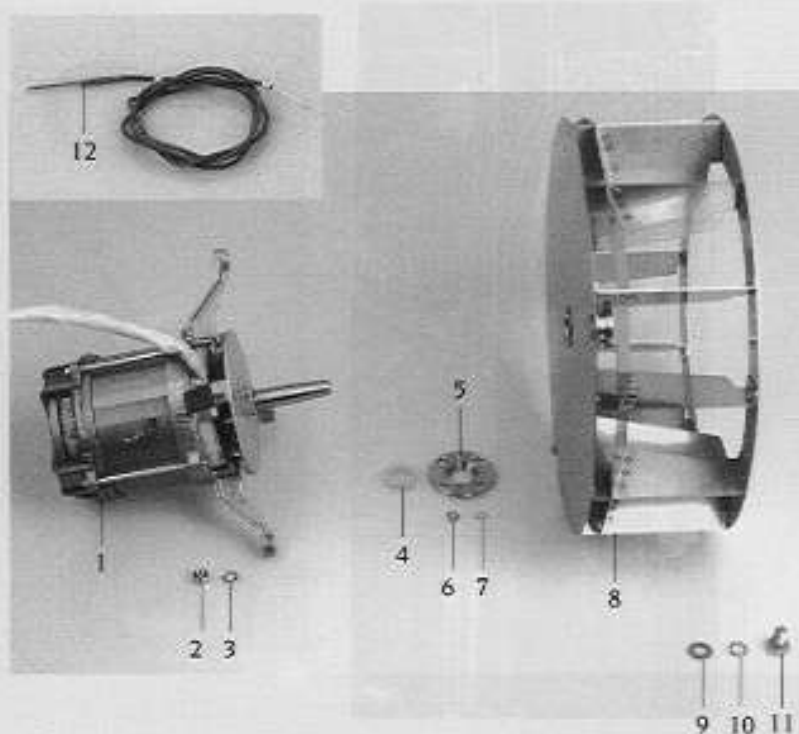
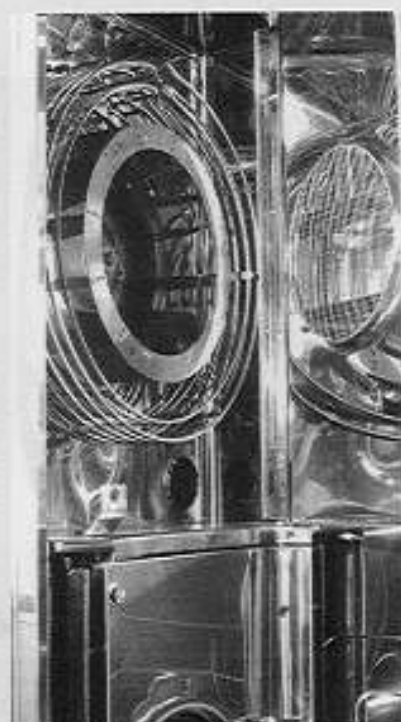

Pos.	St.	Ersatz.Nr.	Bezeichnung	Description
Pos.	Pcs.	Sp. Part No.		
1	2	3100.1000	Lüftermotor	Fan motor
2	8	1108.0260	Sechskantmutter M 8	Hexagonal nut M8
3	8	1208.0160	Zahnscheibe d 8,4	Toothed disc d 8.4
4	2	5001.0207	Motorwellendichtung	Motor shaft gasket
5	2	2016.0876	Dichtungsflansch für Motorwelle	Gasket flange for motor shaft
6	8	1106.0220	Sechskantmutter M6 flach	Hexagonal nut M6 flat
7	8	1315.0101	Kupferdichtung 6x10	Copper gasket 6x10
8	2	2012.0900	Lüfterrad	Fan wheel
9	2	1310.0160	Zahnscheibe A 10,5	Toothed disc A 10.5
10	2	1210.0160	Unterlegscheibe A 10,5	Washer A 10.5
11	2	1010.0760	Sechskantschraube M 10x16	Hexagonal screw M10x16
12	1	3014.0161	Mantelthermoelement	Sheath thermo element
-	1	2066.0201	Schlauchschelle 110-130mm	Hose clamp 110-130mm

Dampfgenerator Steam Generator	Spannung Voltage	Baugruppe Group	Ausgabe Edition	gültig ab Seriennummer Application from Serial.No.
	3 N AC 400V 50Hz	4	4.1.1	C21M93065001

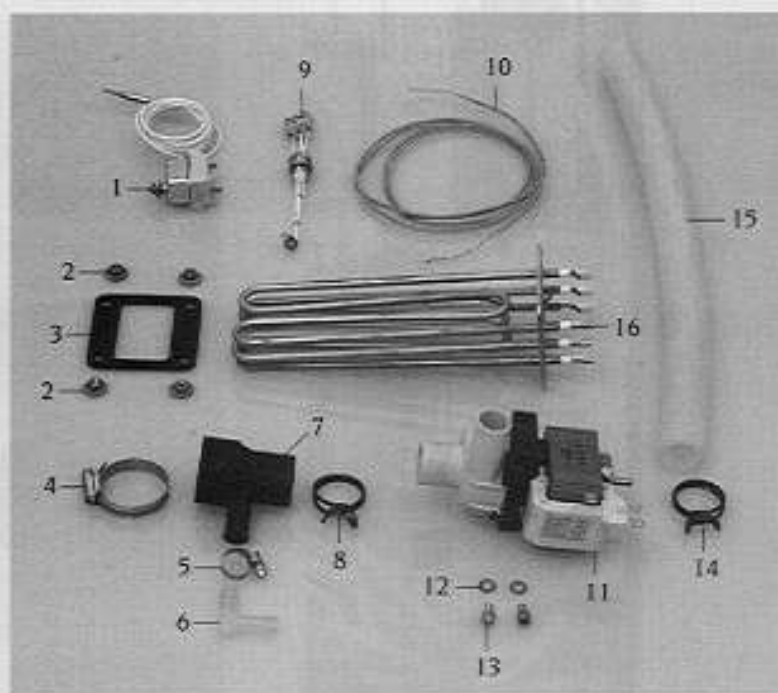
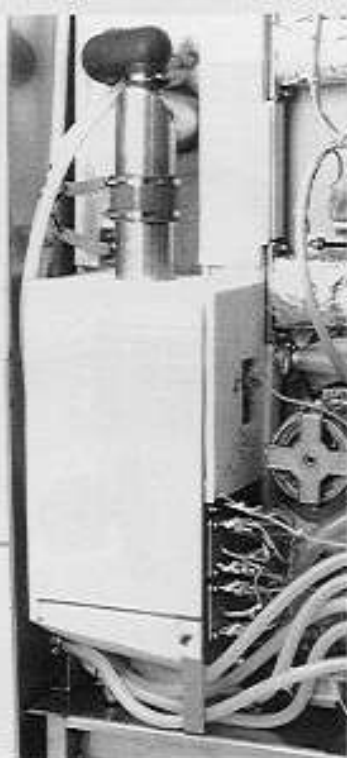

Pos.	St.	Ersatz.Nr.	Bezeichnung	Description
Pos.	Pcs.	Sp. Part No.		
-	1	8350.5000	Dampfgenerator kpl.	Steam generator unit
1	1	3014.0300	Trockengeschutz 125 °	Dry up protector 125 °
-	1	2740.1040	Klemmblech Dampfgenerator	Clamping plate for steam generator
2	16	1106.0801	Sechskant-Combi-Mutter M 6	Hexagonal combination nut M6
3	4	5110.1003	Dichtung f. Tauchheizkörper	Gasket for heating element
4	1	2066.0507	Schlauchschelle 32-50mm	Hose clamp 32-50mm
5	2	2066.0205	Schlauchschelle 12-18mm	Hose clamp 12-18mm
6	1	2062.0301	Winkelstück Kunststoff WS 10	Elbow piece plastic WS 10
7	1	2118.1000	Pumpenanschlußstutzen	Pump connection spout
8	1	2066.0519	Schlauchklemme 35,6mm	Hose clamp 35,6mm
9	1	3002.0402	Füllstandselektrode 90mm.	Filling level electrode 90 mm
10	1	3014.0165	Thermoelement Dampfgenerator	Thermo element steam generator
11	1	3002.1000	Entleerungspumpe 200-240V 50/60Hz	Emptying pump 200-240V 50/60Hz
12	2	1306.0120	Unterlegscheibe A6,4	Washer A6,4
13	2	1006.0621	Innensechskantschraube M 6x12	Allen screw M6x12
14	1	2066.0522	Schlauchklemme 31,3mm	Hose clamp 31,3mm
15	1	2112.1008	Entleerschlauch 22x4x575	Emptying hose 22x4x575
16	4	3201.1000	Tauchheizkörper 3x3 kw/230V	Heating element 3x3 kw/230V

Bodengruppe (Unterseite)	Spannung	Baugruppe	Ausgabe	gültig ab Seriennummer
Bottom (Lower elevation)	Voltage	Group	Edition	Application from Serial.No.
	3 N AC 400V 50Hz	10	10.1.1	C21M93065001

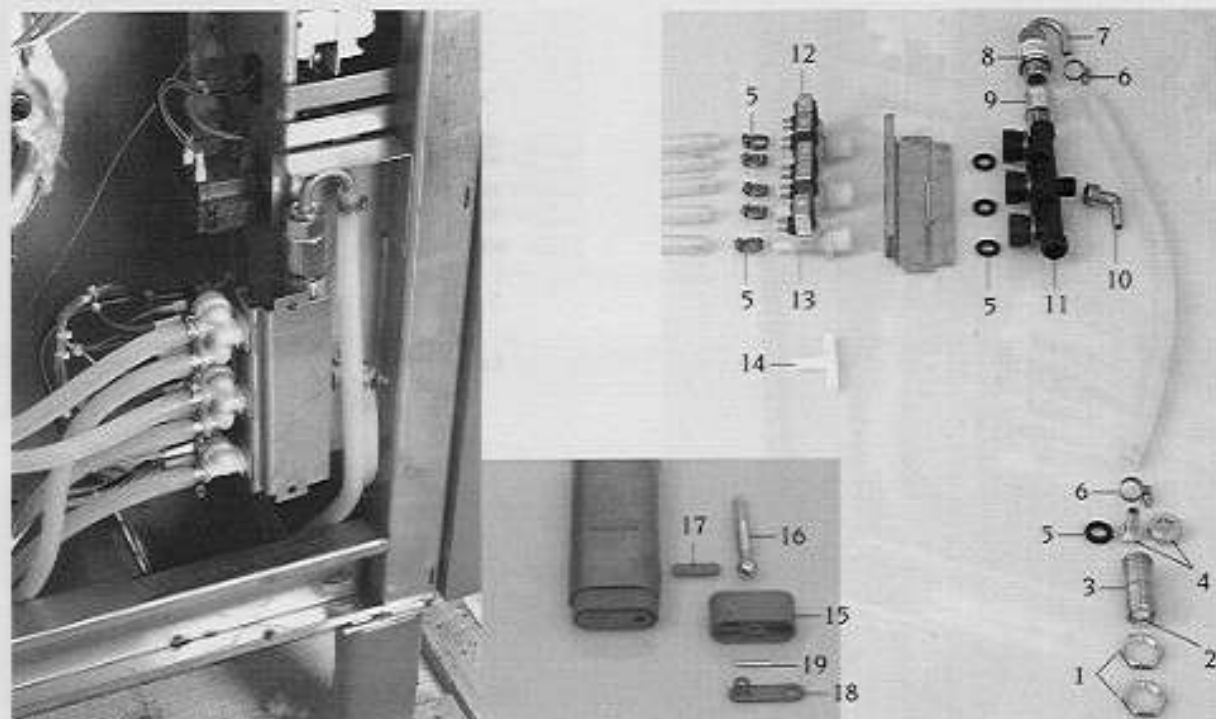

Pos.	St.	Ersatz.Nr.	Bezeichnung	Description
Pos.	Pcs.	Sp. Part No.		
-	-	2067.0050	Silikonschlauch 1m	Silicone hose 1m
-	4	8664.1017	Gerätefuß kpl.	Foot adjustable cpl.
1	2	2062.0313	Kontermutter G 3/4	Lock-nut G 3/4
2	1	1900.0202	Wasserfilter grob	Water filter coarse
3	1	1500.1582	Gewindenippel G3/4"	Thread nipple G3/4"
4	1	2062.0314	Geradeverschraubung G 3/4	Straight threaded joint G 3/4
5	4	5110.1024	Dichtung für Verschraubung G 3/4"	Gasket for G3/4" threaded joint
6	8	2066.0205	Schlauchschelle 12-18mm	Hose clamp 12-18mm
7	1	1500.1571	Rohranschluß	Tube connection
8	1	2069.0102	Armaturenkombination	Valve unit with non-return valve
9	1	1500.1572	Muffe G3/4"	Threaded sleeve G3/4"
10	1	2062.0208	Winkelverschraubung G1/2"x10"	Elbow screw point G1/2"x10"
-	1	5012.0539	Dichtung für Verschraubung G 1/2"	Gasket for G1/2" threaded joint
11	1	8664.1007	Wasserverteiler	Water distribution unit
12	2	3002.0330	Doppelmagnetventil kpl. 220-240V/50Hz	Double solenoid valve unit 220-240V/50Hz
13	1	3002.0331	Einfachmagnetventil kpl. 220-240V/50Hz	Single solenoid valve unit 220-240V/50Hz
14	1	2062.0302	T-Stück TS10	T-piece TS 10
-	2	1106.0801	Sechskant-Combi-Mutter M 6	Hexagonal combination nut M6
15	4	2039.0104	Fußunterteil	Lower part for foot adjustable
16	4	2120.1037	Spindel für Gerätefuß	Spindle for foot adjustable
-	4	1805.1801	Spannhülse A5x12	Adapter sleeve A5x12
17	4	2039.0105	Kunststoffabdeckung	Cover plate
18	4	8664.1018	Fußarretierung	Arrestment for foot adjustable
19	4	1005.1906	Zylinderstift A5x32	Straight pin A5x32

Bodengruppe (Oberseite)	Spannung	Baugruppe	Ausgabe	gültig ab Seriennummer
Bottom (Top elevation)	Voltage	Group	Edition	Application from Serial.No.
	3 N AC 400V 50Hz	9	9.1.1	C21M93063001

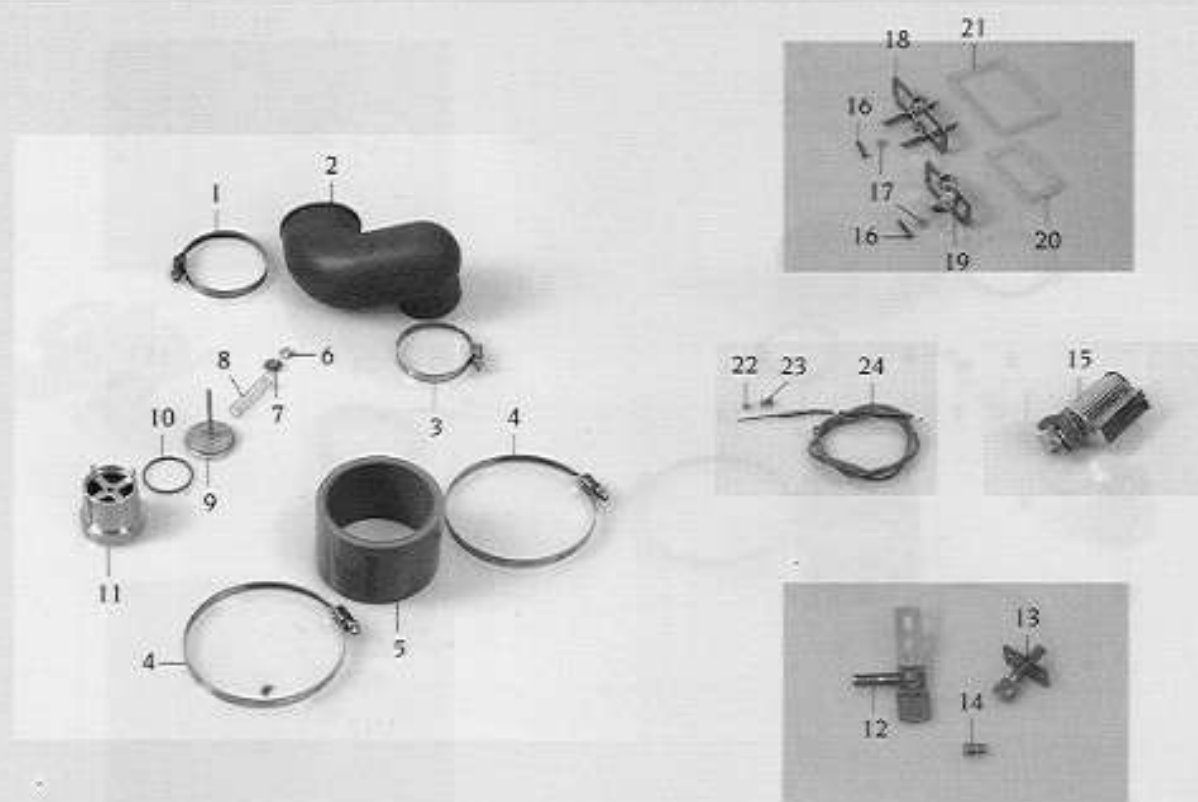

Pos.	St.	Ersatz.Nr.	Bezeichnung	Description
Pos.	Pcs.	Sp. Part No.		
-	-	2067.0050	Silikonschlauch 1m	Silicone hose 1m
-	1	8450.1001	Sicherheitsventil kpl.	Safety valve unit.
1	1	2066.0300	Schlauchschele 50-70mm	Hose clamp 50-70mm
2	1	5012.0570	Haube f. Sicherheitsventil	Cap for safety valve
3	1	2066.0504	Schlauchschele 40-60mm	Hose clamp 40-60mm
4	2	2066.0524	Schlauchschele 90-110mm	Hose clamp 90-110mm
5	1	2112.1016	Dampfschlauch 80x7mm	Steam hose 80x7mm
6	1	1107.0100	Schnellbefestiger 4.0 mm	Quick fastener 4.0 mm
7	1	1105.0122	Sechskant-Combi-Mutter M 5	Hexagonal combination nut M5
8	1	2064.1002	Unterdruckfeder f. Sicherheitsventil	Vacuum/depression spring for safety valve
9	1	2064.1001	Unterdruckstempel f. Sicherheitsventil	Vacuum/depression ram for safety valve
10	1	2064.1003	Unterdruckdichtung f. Sicherheitsventil	Vacuum/depression gasket for safety valve
11	1	2064.1000	Überdruckgewicht f. Sicherheitsventil	Overpressure weight for safety valve
-	1	2064.1004	Überdruckgewichtdichtung f. Sicherheitsventil	Overpressure weight gasket for safety valve
12	1	8666.1049	Ablöschdüse Ablaufkasten	Quenching nozzle for outlet box
13	3	8666.1045	Ablöschdüse kpl. 3.9 l/min.	Quenching nozzle unit 3.9 l/min.
-	3	5110.1013	Dichtung Ablöschdüse	Gasket for quenching nozzle
14	1	2035.0111	Zungendüse für Beschwadung	Molstening nozzle
15	1	3101.1004	Querstromlüfter	Cooling fan
16	2	1008.0751	Sechskantschraube M5x25	Hexagonal screw M 5x25
17	2	1315.0260	Unterlegscheibe A5.3	Washer A5.3
18	1	2940.1014	Fixierung groß für Gerätedeckel	Large fixing for top cover
19	1	2940.1016	Fixierung klein für Gerätedeckel	Small fixing for top cover
20	1	5110.1019	Dichtung klein für Ablöschkanal/ Gerätedeckel	Small gasket for quenching channel/top cover
21	1	5110.1018	Dichtung groß für Ablöschkanal/ Gerätedeckel	Large gasket for quenching channel/top cover
22	1	3014.0162	Dichtkegel für Thermoelement	Sealing cone for thermo element
23	1	3014.0163	Stopfbuchsnippel für Thermoelement	Gasket sleeve with nipple
24	1	3014.0161	Mantelthermoelement	Sheath thermo element

ClimaPlus	Spannung	Baugruppe	Ausgabe	gültig ab Seriennummer
ClimaPlus	Voltage	Group	Edition	Application from Serial.No.
	3 N AC 400V 50Hz	3	3.1.1	C21M93065001

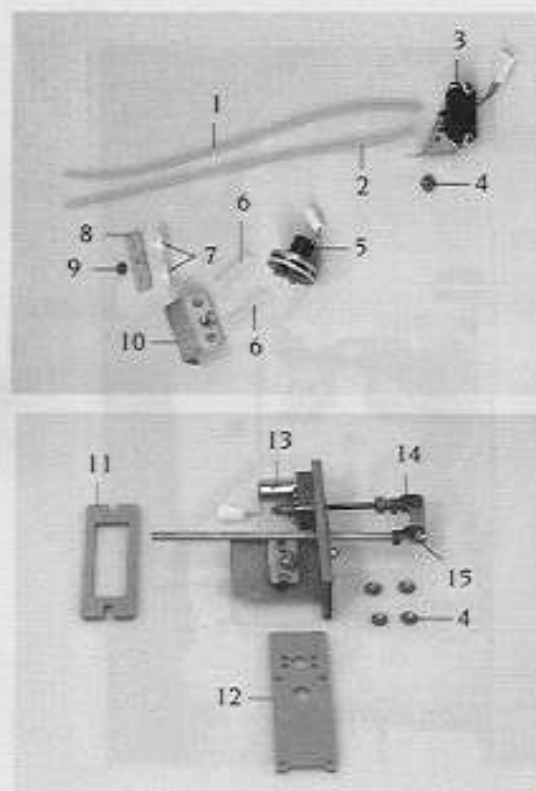
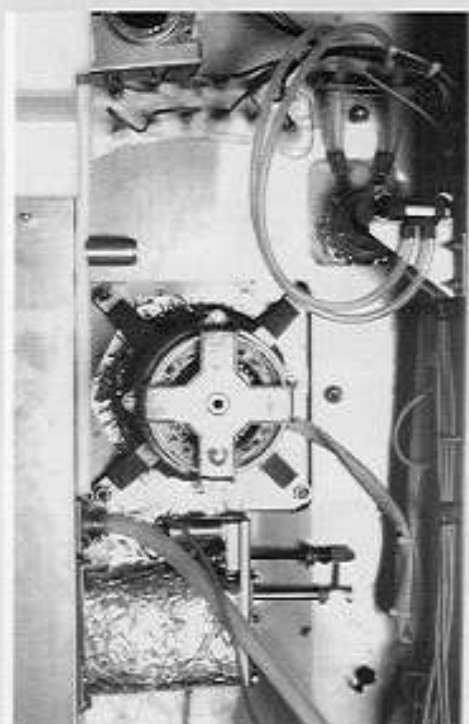

Pos.	St.	Ersatz.Nr.	Bezeichnung	Description
Pos.	Pcs.	Sp. Part No.		
-	1	3040.2602	Platine kpl. f. Feuchtmotor	PCB cpl. for sensor motor
-	1	8680.1008	Kondensatfilter vormontiert (Pos. 6-10)	Pre-fitted condenser filter (pos. 6-10)
1	1	2112.1012	Druckschlauch blau d 3x2,5x500mm	Pressure hose blue d 3x2,5x500mm
2	1	2112.1013	Druckschlauch rot d 3x2,5x500mm	Pressure hose red d 3x2,5x500mm
3	1	8680.1018	Drucksensor kpl. 164PC	Pressure sensor unit 164PC
4	9	1105.0122	Sechskant-Combi-Mutter M 5	Hexagonal combination nut M5
5	1	8680.1006	Motor f. Feuchtmessung kpl.	Sensor motor
6	2	2112.1014	Druckschlauch 8x2x80	Pressure hose 8x2x80
-	2	2112.1015	Druckschlauch 5x1,5x10	Pressure hose 5x1,5x10
7	2	1900.0201	Kondensatfilter	Condensation filter
8	1	2760.1067	Filterhalter oben	Holder top for condensation filter
9	1	1106.0801	Sechskant-Combi-Mutter M6	Hexagonal combination nut M6
10	1	8680.1016	Filterhalter unten	Holder below condensation filter
11	2	5110.1011	Dichtung Ablöschkanal Stellschieber	Gasket for quenching channel set slider
12	2	5110.1014	Dichtung Verschlussflansch	Gasket for closure flange
13	2	3101.1001	Stellmotor f. Schieber	Servo motor for slider
14	2	2016.0402	Federklappbolzen 6x12mm	Cap bolt with locking spring 6x12 mm
15	2	2016.0403	Federklappbolzen 4x16mm	Cap bolt with locking spring 4x16 mm
16	1	3014.0162	Dichtkegel für Thermoelement	Sealing cone for thermo element
17	1	3014.0163	Stopfbuchsnippel für Thermoelement	Gasket sleeve with nipple
18	1	3014.0161	Mantelthermoelement	Sheath thermo element

Bedienblende Control Panel	Spannung Voltage 3 N AC 400V 50Hz	Baugruppe Group 1	Ausgabe Edition 1.1.1	gültig ab Seriennummer Application from Serial.No. C21M93065001
--------------------------------------	---	-------------------------	-----------------------------	---

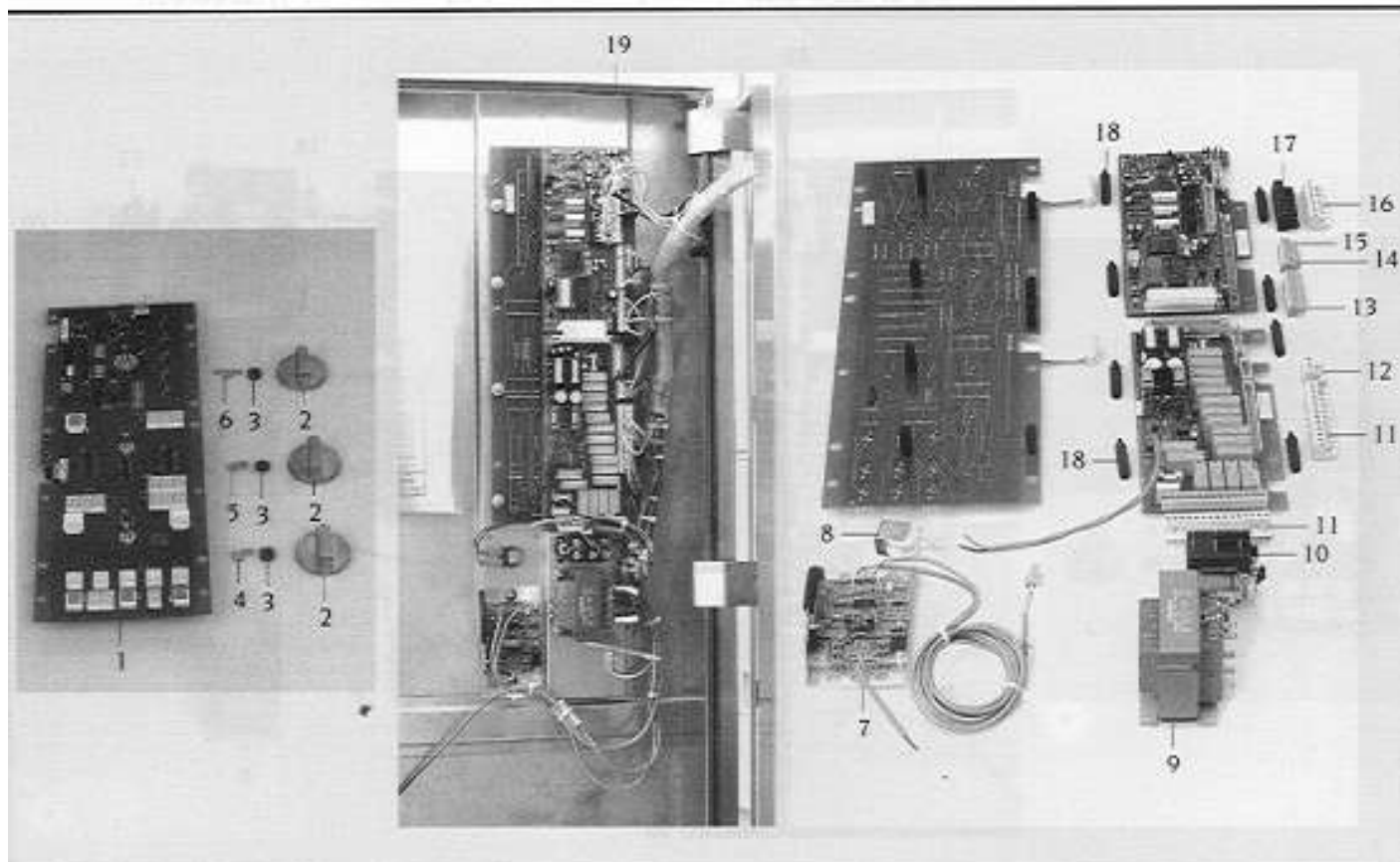

Pos.	St.	Ersatz.Nr.	Bezeichnung	Description
Pos.	Pcs.	Sp. Part No.		
-	1	8461.5002	Bedienblende kpl.	Control panel
1	1	3040.2050	Regel und Steuerelektronik kpl.	PCB complete
-	9	2039.0326	Silikonfeder	Silicone spacer
2	3	3013.0344	Knebel CCD/CCM blau Ø 60mm	Dial CCD/CCM blue Ø 60mm
		3013.0330	Knebel CCD/CCM blau Ø 40mm	Dial CCD/CCM blue Ø 40mm
3	3	5110.1027	Distanzscheibe	Distance plate
4	1	2760.1100	Arretierung für Poti Kerntemperatur	Arrestment for Poti core temperature
5	1	2510.530746	Arretierung für Poti Heißluft	Arrestment for Poti hot air
6	1	2760.1129	Arretierung für Poti Betriebsartenschalter	Arrestment for Poti mode switch block
7	1	3040.2602	Platine für Feuchtmotor	PCB for sensor motor
8	1	3006.0103	Alarmsummer	Alarm buzzer
9	1	3037.0203	Steuertrafo 35VA	Transformer 35VA
10	1	3028.0601	Kleinschütz E 3250, 24V	Mini contactor E 3250, 24V
11	2	3040.0230	Steckerleiste BL 15	Multipoint connector BL15
12	1	3040.0194	Steckerleiste BL 4	Multipoint connector BL4
13	1	3040.0227	Steckerleiste BL 12	Multipoint connector BL12
14	1	3040.0228	Steckerleiste BL 9	Multipoint connector BL9
15	1	3040.0229	Steckerleiste BL 3	Multipoint connector BL3
16	1	3040.0232	Steckerleiste grau BL 10	Multipoint connector grey BL10
17	1	3040.0231	Steckerleiste schwarz BL 10	Multipoint connector black BL10
18	16	1403.0169	Abstandsbolzen M4x25	Spacing bolt M4x25
-	1	3016.1408	Türkontaktschalter	Door contact switch
19	1	5105.1013	Dichtungsrahmen f. Bedienblende	Gasket frame for panel

Gerätetür	Spannung	Baugruppe	Ausgabe	gültig ab Seriennummer
Door	Voltage	Group	Edition	Application from Serial.No.
	3 N AC 400V 50Hz	8	8.1.1	C21M93065001

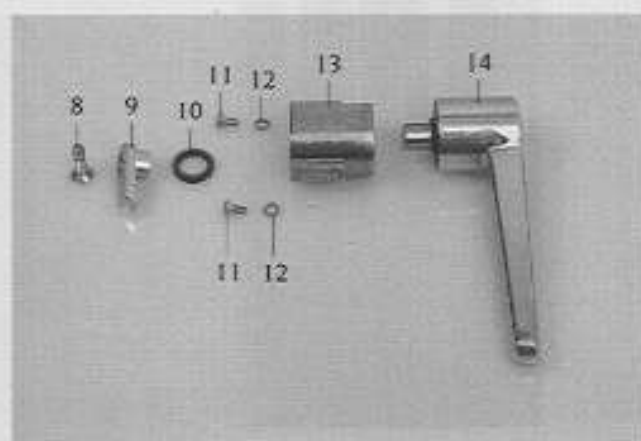
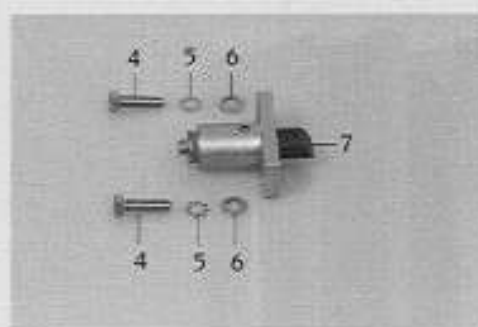

Pos.	St.	Ersatz.Nr.	Bezeichnung	Description
Pos.	Pcs.	Sp. Part No.		
-	1	8470.5001	Gerätetür kpl.	Door cpl.
-	1	5200.1003	Glasscheibe innen	Internal glass panel
-	1	5105.1005	Dichtungsrahmen für Glasscheibe	Gasket frame for internal glass panel
1	1	8474.1020	Glastür außen kpl.	External glass door unit
2	1	5105.1015	Dichtungsprofil HGW/ Garraum	Gasket profile HGW/ interior cabinet
3	1	5105.1007	Dichtungsrahmen Tür/ Garraum	Gasket frame door/ interior cabinet
4	2	1008.0761	Sechskantschraube M8x25	Hex screw M8x25
5	2	1206.0120	Zahnscheibe A6,4	Toothed lock washer A6,4
6	2	1308.0160	Unterlegscheibe A8,4	Washer A8,4
7	1	8514.1038	Fangkloben kpl.	Door catch cpl.
8	1	1008.1960	Senkschraube M8x30	Countersunk screw M8x30
-	1	2039.0309	Abdeck- Kappe	Silicone cap
9	1	2940.1004	Riegel	Door bolt
10	1	5110.1015	Dichtungsring	Sealing washer
11	2	1006.0760	Sechskantschraube M6x16	Hex screw M6x16
12	2	1306.0120	Unterlegscheibe A6,4	Washer A6,4
13	1	8474.1019	Verschluß kpl.	Lock unit
14	1	2016.1501	Türhebel	Door handle

Elektromontageplatte Electrical Installation	Spannung Voltage	Baugruppe Group	Ausgabe Edition	gültig ab Seriennummer Application from Serial.No.
	3 N AC 400V 50Hz	2	2.1.1	C21M93065001

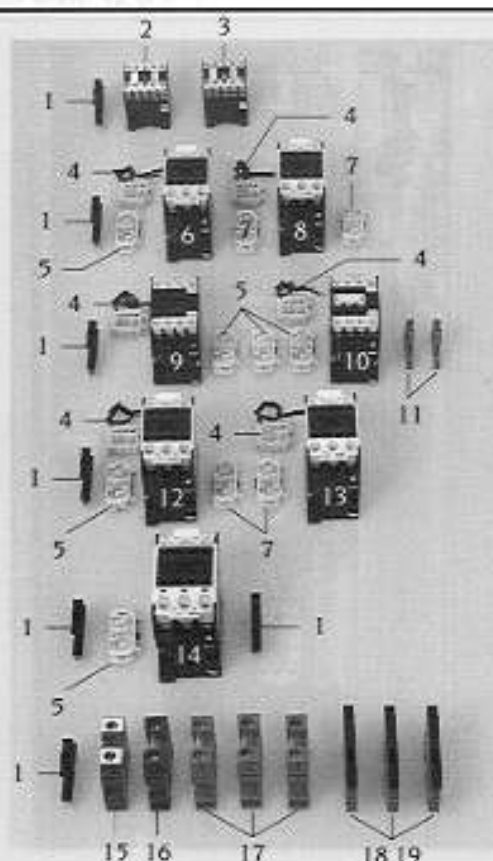
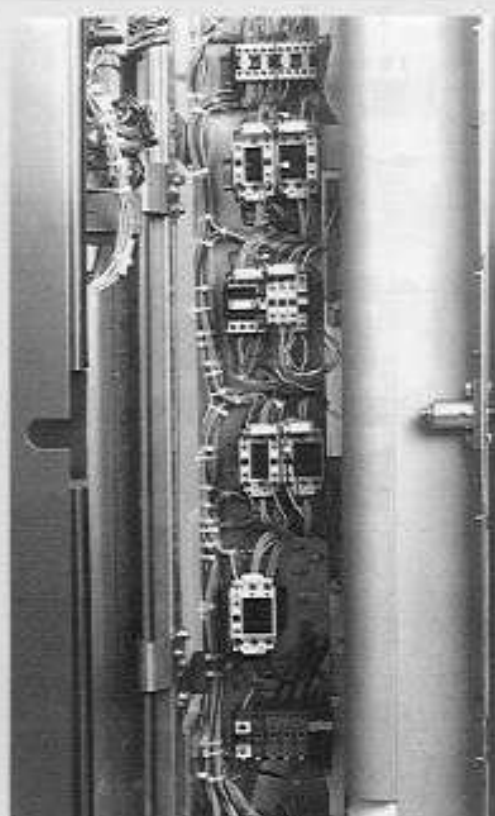

Pos.	St.	Ersatz.Nr.	Bezeichnung	Description
Pos.	Pcs.	Sp. Part No.		
1	1	4001.1203	Endklammer für Tragschiene	End terminal for supporting rail
2	2	3028.0504	Schütz LS 05.01 230V 50/60Hz	Contacteur LS 05.01 230V 50/60Hz
3	2	3028.0504	Schütz LS 05.01 230V 50/60Hz	Contacteur LS 05.01 230V 50/60Hz
-	2	3035.0517	RC-Glied	RC-Link
4	1	3035.0515	RC-Glied	RC-Link
5	6	3028.0153	Hilfskontaktschalter HS 17.10	Auxiliary contact switch HS 17.10
6	1	3028.0510	Schütz LS 27.00 220-240V 50/60Hz	Contacteur LS 27.00 220-240V 50/60Hz
7	4	3028.0156	Hilfskontaktschalter HS 17.01	Auxiliary contact switch HS 17.01
8	1	3028.0510	Schütz LS 27.00 220-240V 50/60Hz	Contacteur LS 27.00 220-240V 50/60Hz
9	1	3028.0507	Schütz LS 04.01 220-240V 50/60Hz	Contacteur LS 04.01 220-240V 50/60Hz
10	1	3028.0507	Schütz LS 04.01 220-240V 50/60Hz	Contacteur LS 04.01 220-240V 50/60Hz
11	2	4001.1216	Reihenklemme 4mm ² grau	Terminal 4mm ² grey
12	1	3028.0510	Schütz LS 27.00 220-240V 50/60Hz	Contacteur LS 27.00 220-240V 50/60Hz
13	1	3028.0510	Schütz LS 27.00 220-240V 50/60Hz	Contacteur LS 27.00 220-240V 50/60Hz
14	1	3028.0512	Schütz LS 37.00 220-240V 50/60Hz	Contacteur LS 37.00 220-240V 50/60Hz
15	1	4001.1233	Erdungsreihenklemme 35mm ² gelb/grün	Earth terminal 35mm ² yellow/green
16	1	4001.1252	Reihenklemme 35mm ² blau	Terminal 35mm ² blue
17	3	4001.1206	Reihenklemme 35mm ² grau	Terminal 35mm ² grey
18	3	4001.1247	Sicherungsklemme	Fuse holder
19	3	4001.0218	Feinsicherung 6,3A	Fuse 6.3A
-	1	3102.1000	RC-Glied	RC-Link

Elektromontageplatte Electrical Installation	Spannung Voltage	Baugruppe Group	Ausgabe Edition	gültig ab Seriennummer Application from Serial.No.
	3 N AC 400V 50Hz	2	2.2.1	C21M93065001

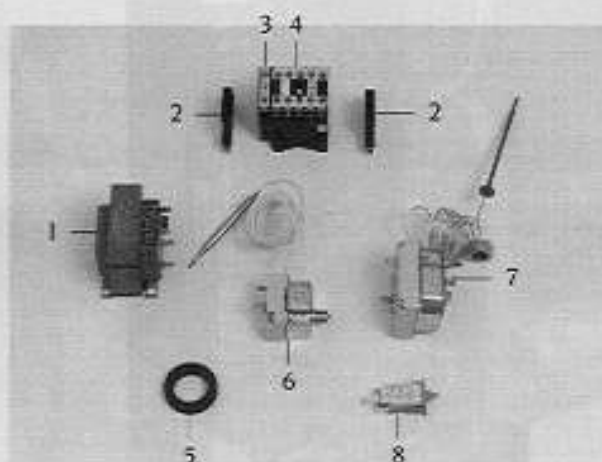
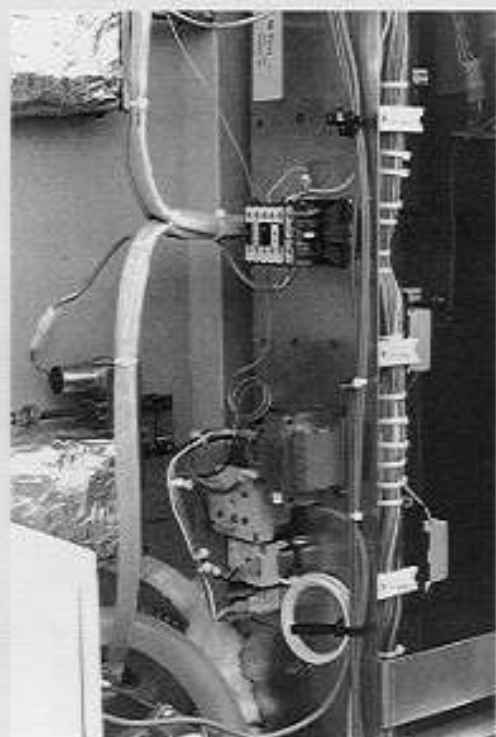

Pos.	St.	Ersatz.Nr.	Bezeichnung	Description
Pos.	Pcs.	Sp. Part No.		
1	1	3037.0204	Halogentrafo	Halogen transformer
2	2	4001.1203	Endklammer für Trageschiene	End terminal for supporting rail
3	1	3028.0158	Hilfskontaktschalter HS 05.01	Auxiliary contact switch HS 05.01
4	1	3028.0504	Schütz LS 05.01 230V 50/60Hz	Contacteur LS 05.01 230V 50/60Hz
5	2	2022.0105	Durchführungsstülpe d 26mm	Lead-in grommet d 26mm
6	1	3014.0300	Trockengehschutz 125°C	Dry up protector 125°C
7	1	3014.0322	Sicherheitstemperaturbegrenzer 360°C	Safety temperature limiter 360°C
8	1	3014.0400	Überstromauslöser einpolig	Current limiter for motor protection

Handbrause Hand Shower	Spannung Voltage	Baugruppe Group	Ausgabe Edition	gültig ab Seriennummer Application from Serial.No.
	3 N AC 400V 50Hz	11	11.1.1	C21M93065001

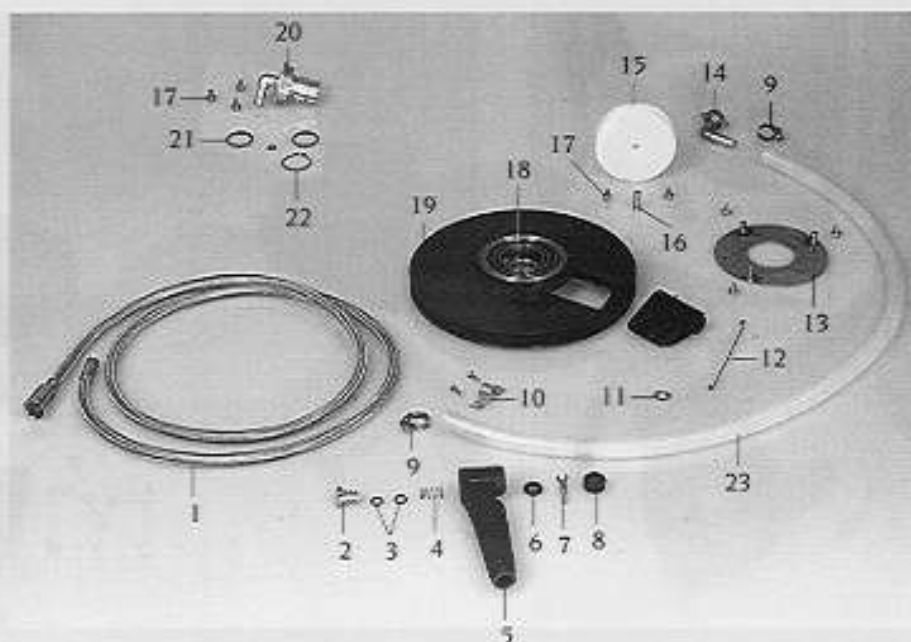
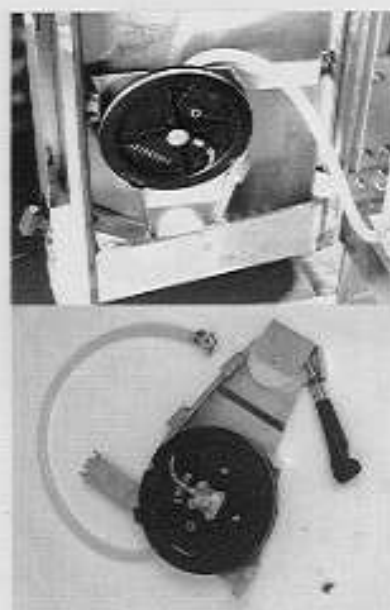

Pos.	St.	Ersatz.Nr.	Bezeichnung	Description
Pos.	Pcs.	Sp. Part No.		
-	-	8655.3000	Schlauchroller kpl.	Hand shower roll guide
1	1	2067.0607	Brauseschlauch 1500 mm	Shower hose 1500 mm
-	2	2060.0228	O-Ring	O-ring
2	1	2060.1001	Druckknopf für Handbrause	Push-button for hand shower
3	2	5012.0559	O-Ring f. Schlauchbrause d 7x2,5mm	O-ring d 7x2,5mm
4	1	2001.0110	Druckfeder f. Schlauchbrause	Compression spring
5	1	2060.1000	Handbrause kpl. (inkl.Pos 2-8)	Hand shower (incl.Pos 4-9)
6	1	5012.0558	O-Ring f. Schlauchbrause d 8x5mm	O-ring d 8x5mm
7	1	2060.1003	Steilkegelstift Handbrause	Steep taper pin for hand shower
8	1	2060.1002	Düse f. Handbrause	Jet for hand shower
9	1	2066.0205	Schlauchschelle 12-18mm	Hose clamp 12-18mm
10	1	2760.1159	Befestigungsschelle	Hose clamp
-	2	1003.0231	Kerbschraube 3,9x13 mm	Slotted screw 3.9 x 13 mm
11	1	2001.0203	Federmutter d 8mm	Spring nut d 8 mm
12	1	2001.0202	Bügelfeder f. Schlauchroller	Return spring for hose roll guide
13	1	8655.2005	Sicherungsscheibe	Locking plate
14	1	2062.0208	Winkelverschraubung G1/2"x10	Elbow screw point G1/2"x10
-	1	5012.0539	Dichtung für Verschraubung G 1/2"	Gasket for G1/2" threaded joint
15	1	2060.0112	Schlauchrolle	Roll guide
16	1	2060.0115	Achse für Schlauchrolle	Axle for roll guide
17	10	1005.2000	Sperrzahnschraube M5x8	Interlocking tooth screw M5x8
18	1	2001.0201	Spiralfeder f. Schlauchroller	Spiral coiled spring for hose roll guide
19	1	2060.0150	Schlauchrad für Handbrause	Retractable wheel for hand shower
20	1	2060.0157	Achse f. Schlauchroller	Axle for hose roll
21	1	8000.0081	Satz O-Ringe	Set O-ring
22	1	1250.0103	Sicherungsring 28mm	Snap ring 28mm
23	1	2067.0159	Silikonschlauch 900mm	Silicone hose 900mm

Heißluftheizung Hot Air Heating	Spannung Voltage	Baugruppe Group	Ausgabe Edition	gültig ab Seriennummer Application from Serial.No.
	3 N AC 400V 50Hz	5	5.1.1	C21M93065001

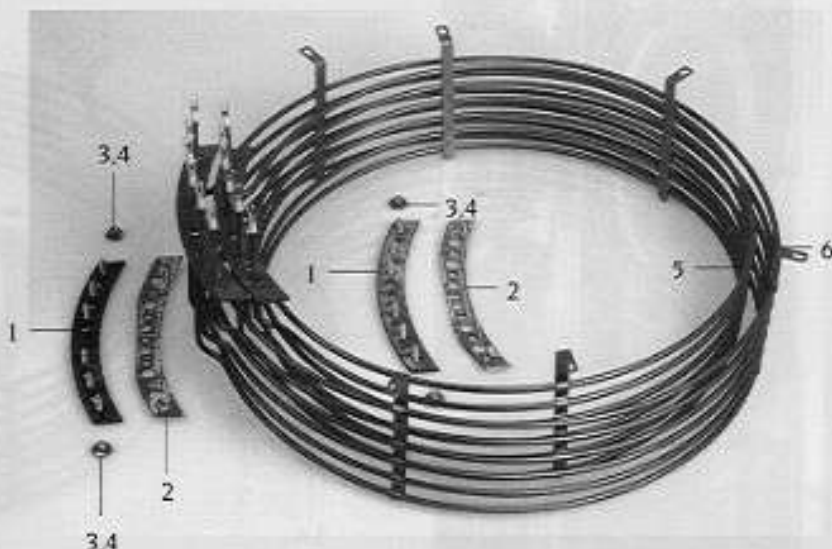
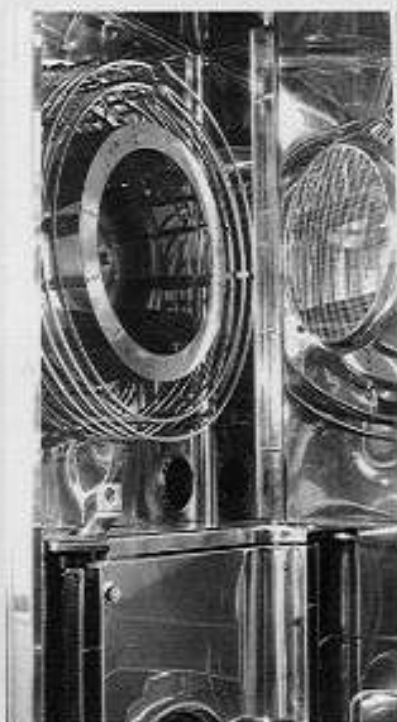

Pos.	St.	Ersatz.Nr.	Bezeichnung	Description
Pos.	Pcs.	Sp. Part No.		
1	4	2150.1005	Flansch Außenseite f. Heizregister	External flange for heating element
2	8	5110.1009	Dichtring f. Heizregister	Seal ring for heating assembly
3	36	1206.0261	Federring B6	Spring washer B6
4	36	1106.0360	Hutmutter M6	Cap nut M6
5	2	3200.1000	Heizregister innen 230V	Inner heating assembly 230V
6	2	3200.1001	Heizregister außen 230V	Outer heating assembly 230V